

## Completion Report

On

**Implementation of recharge shafts as an adaptation option and building capacity of officials of Water Resource Department as part of the pilot project on PGWM in Burhanpur and Ratlam Districts of Madhya Pradesh**



**August 2018**



**National Centre for Human Settlements and Environment**

E-5/A, Girish Kunj, Arera Colony, Bhopal-462016

Ph. 0755-2463731, 2465306, E-mail: [nchsebpl@gmail.com](mailto:nchsebpl@gmail.com)

Web: [www.nchse.org](http://www.nchse.org)

## **1. Background:**

### ***1.1 Project Overview:***

United Nations Development Programme (UNDP) in partnership with MoEFCC and Swiss Agency for Development and Cooperation (SDC) is implementing a project titled “Strengthening State Strategies for climate Actions” with an overall goal to integrate climate change actions into sub national planning, benefitting local communities in India. The goal is to be achieved by strengthening capacities of state level departments and relevant institutions to plan and undertake specific interventions in climate sensitive sectors impacting large sections of vulnerable communities of select States, including Madhya Pradesh.

The SDC-UNDP partnership aims to assist the State Nodal Agency and the sectoral departments in the implementation of the SAPCC with focus on water sector in Madhya Pradesh. The major interventions in these sectors include mobilization of appropriate expertise, capacity building of resource persons/institutions, facilitation of implementation of strategies and knowledge sharing. The project is primarily geared towards creating a model for the implementation of the State Action Plan on Climate Change (SAPCC) at the state level. In Madhya Pradesh, the focus is on the groundwater use in agriculture sector and the project will look at strengthening strategies for ground water resource planning and management.

### ***1.2 Context:***

Groundwater usage in Madhya Pradesh has dramatically increased over the last couple of decades and it is now a major source of water for agriculture and ensuring drinking water security. With an estimated 15 billion cubic meters (bcm) groundwater extraction, the state is fast hurtling towards a serious crisis of groundwater overuse and groundwater contamination. Further, it remains the only drinking water source for most of the rural households in the state. Its over-exploitation has been causing shortages of water for irrigation and drinking. The Dynamic Ground Water Resources of Madhya Pradesh, 2015, prepared by MPWRD and Central Water Ground Board (CWGB) stated that majority of Madhya Pradesh’s districts were showing alarmingly levels of groundwater over exploitation and half of the districts come under semi-critical, critical and over exploited category. This report has also indicated that most of the districts in the Malwa region have shown highest levels of groundwater over exploitation, current and future vulnerability to the groundwater shortages. Therefore, as part of the 3SCA project a pilot intervention on Participatory Groundwater Management (PGWM) is being implemented under the partnership of UNDP and MPWRD in 2 micro watersheds of Burhanpur and Ratlam districts for building the climate resilience of the local communities.

### ***1.3 The Assignment:***

In order to implement the pilot intervention, UNDP hired National Centre for Human Settlements and Environment (NCHSE), Bhopal for the implementation of the pilot project in Burhanpur and Ratlam districts of Madhya Pradesh.

## **2. Objectives:**

The objective of this assignment was to construct recharge shafts and build the capacity of the stakeholders' in implementation, maintenance and management of recharge shafts as a climate adaptation option.

## **3. Project Implementation:**

In the meeting between UNDP and NCHSE held on 1<sup>st</sup> June 2018 in Bhopal, the project implementation plan was finalized. In the meeting officials of UNDP-State Project Management Unit, Bhopal, viz. Shri Rajat Kumar Choudhury, State Manager, Shri Akshay Srivastava, Project Associate and Shri N.Mohan Reddy, Technical Expert and NCHSE represented by Dr Pradip Nandi, Director General, Shri K. S. Banerjee, Dy Director and Dr. R. M. Singh, Geo hydrologist were present. The contract (2018/046) for the implementation of the project within 45 days, i.e by 15<sup>th</sup> July 2018 was signed between UNDP and NCHSE on the same day.

Initially the date for completion of activities was fixed with the understanding that the works could be completed before the arrival of monsoon. The entire works of validation, identification of points for recharge shaft and slug tests, slug tests itself in both the districts and construction of recharge shafts in Burhanpur were completed in time. However, due to early arrival of monsoon followed by intermittent showers, prevented completion of recharge shafts construction in Ratlam District. Further, these structures also required additional support works such as construction of a retaining wall to protect one of the recharge shafts and Loose Boulder Structures (LBS) on both upstream and downstream of the recharge shafts. Therefore, after thorough review, UNDP agreed to include these additional works for Ratlam District. Accordingly, the Contract was amended with addition of extra works, cost and extended time for work completion by 15<sup>th</sup> August 2018.

## **4. Activities Undertaken:**

Following activities were undertaken:

### ***4.1 Validation and Identification of Points for Recharge Shaft and Slug Tests:***

#### ***4.1.1 Burhanpur District:***

The validation and identification of points in Sangrampur village in Burhanpur Block of Burhanpur District was completed during 4<sup>th</sup> to 6<sup>th</sup> June, 2018. Following activities were conducted during this period:

- i. Held discussions with the Sarpanch and Secretary of Gram Panchayat and farmers of the village;
- ii. Identified Recharge Shaft points as proposed in the TOR as well as additional 2 points through GPS;
- iii. Identified 4 existing bore wells near to the locations of recharge shaft sites mentioned in the TOR as potential sites for slug tests and recorded their coordinates through GPS;

- iv. Verified the ownership of land of all the points for Recharge shaft and bore wells for Slug tests;
- v. Mobilised farmers for slug tests;
- vi. Obtained NOC for the construction of Recharge shafts from Gram Panchayat and concerned farmers for slug tests.

#### **4.1.2 Ratlam District:**

The validation and identification works took place in Gudarkheda village in Piploda Block of Ratlam District during 5<sup>th</sup> to 7<sup>th</sup> June, 2018. Following activities were conducted during this period:

- i. Held discussions with the Sarpanch and Secretary of Gram Panchayat and farmers of the village.
- ii. Identified two sites for Recharge Shaft as proposed in the TOR through GPS;
- iii. Marked 5 existing bore wells near to the locations of recharge shaft sites mentioned in the TOR as potential sites for slug tests and recorded four coordinates through GPS coordinates for one hand pump installed by Gram Panchayat on Government land;
- iv. Verified the ownership of land of all the points for Recharge shaft and bore wells for Slug tests;
- v. Mobilized farmers/land owners for slug tests;
- vi. Obtained NOC for Slug Tests from Gram Panchayat and concerned farmers/land owners.

#### **4.2 Feasibility study for Identification of the Recharge Shaft Locations in Burhanpur and Ratlam:**

##### **4.2.1 Potential Sites:**

The field study (slug tests post site verification) was conducted in an unconfined and confined aquifer at two locations each at Burhanpur and Ratlam districts. The aquifer has flow sheet like features in basaltic lava flow which is relatively homogeneous in nature and laterally extensive aquifer of nearly uniform thickness, and a horizontal water table overlain by a flat topography. The sandy soil and weathered basaltic material deposit is 12 to 15 m thick and is underlain by a thick deposit of basalts in Ratlam and Burhanpur.

The identification of the recharge points were carried out based on the water accumulation potential, local land use, geo physical information etc. The possible recharge zones favourable for taking up artificial recharge measures the geomorphology, hydrogeology, groundwater fluctuation, soil type and soil depth were initially used to identify the artificial recharge zones. The recharge points for location of recharge shafts have been identified based on the extensive field surveys and interaction with expert geologist and the list of points are given in Table 1&2.

**Table 1: Location of Proposed Recharge Shaft and Injection Wells in Sangrampur Village, Burhanpur District**

S. No.	Name	Longitude	Latitude
1	Recharge Shaft 1	76.3901	21.1945
2	Recharge Shaft 2	76.3879	21.1928
3	Recharge Shaft 3	76.3854	21.1944
4	Injection Well 1	76.3638	21.2253
5	Injection Well 2	76.3681	21.2228
6	Injection Well 3	76.3705	21.2219
7	Injection Well 4	76.3769	21.2201
8	Injection Well 5	76.3803	21.2187
9	Injection Well 6	76.3810	21.2173
10	Injection Well 7	76.3827	21.2178
11	Injection Well 8	76.3871	21.2176
12	Injection Well 9	76.3895	21.2181
13	Injection Well 10	76.3946	21.2155
14	Injection Well 11	76.3860	21.2097
15	Injection Well 12	76.3783	21.2132
16	Injection Well 13	76.3793	21.2039
17	Injection Well 14	76.3799	21.2016
18	Injection Well 15	76.3719	21.2054
19	Injection Well 16	76.3693	21.2113
20	Injection Well 17	76.3688	21.2139
21	Injection Well 18	76.3629	21.2227

**Table 2: Location of Proposed Injection Wells in Gudarkheda Village in Ratlam District**

S. No.	Name	Longitude	Latitude
1	Injection Well	23.5622	74.8747
2	Injection Well	23.5621	74.8749
3	Injection Well	23.5619	74.8751
4	Injection Well	23.5618	74.8752
5	Injection Well	23.5574	74.8883
6	Injection Well	23.5569	74.8883
7	Injection Well	23.5581	74.8890
8	Injection Well	23.5591	74.8895
9	Injection Well	23.5637	74.8880
10	Injection Well	23.5641	74.8904
11	Injection Well	23.5643	74.8940

**4.2.2 Feasibility Matrix:**

The Slug tests were conducted for the 4 exploratory wells (two each in Sangrampur and Gudarkheda) and 4 additional bore wells in each village. The feasibility of sites in Sangrampur village in Burhanpur District was prepared based on the assumed depth of recharge shaft of 90 to 110 meter. It is because of results of slug test of the pilot recharge

shafts and keeping in view the general bore well depth in the area and aquifer parameters. The recharge shaft depth in Gudarkheda village of Ratlam district is good.

It is suggested that the location of high priority recharge shafts may come together in a place due to high potential area of recharge, so the selection of next lower feasibility recharge shaft may be taken up. Details of final sites selected for the installation of recharge shafts at both the villages are presented at Table 3&4.

**Table 3: Feasible sites for recharge shafts at Gudarkheda, Ratlam**

S. No.	Latitude	Longitude	Stru ID	Final Selection
1	23.5641000	74.8904000	RS-10	Feasible-1
2	23.5622000	74.8850000	RS-12	Feasible-2
3	23.5607000	74.8780000	RS-13	Feasible-3
4	23.5643000	74.8940000	RS-11	Feasible-4
5	23.5618000	74.8752000	RS-04	Feasible-5
6	23.5641000	74.8888000	RS-09	Feasible-7
7	23.5591000	74.8895000	RS-08	Feasible-6

**Table 4: Feasible sites for recharge shafts at Sangrampur, Burhanpur**

S. No.	Latitude	Longitude	Stru ID	Final Selection
1	21.1945000	76.3901000	RS-1	Feasible-1 (If permitted in pond)
2	21.1928000	76.3879000	RS-2	Feasible-1 (If permitted in pond)
3	21.2039000	76.3787000	RS-13	Feasible-3
4	21.2013000	76.3793000	RS-14	Feasible-2
5	21.1944000	76.3854000	RS-3	Feasible-1
6	21.2187600	75.3810600	RS-5	Feasible-4
7	21.2184000	76.3898000	RS-9	Feasible-5
8	21.216080	76.3788000	RS-12	Feasible-6
9	21.2054000	76.3722000	RS-15	Feasible-7

**Note:** Priority of the proposed recharge shaft is applicable to the local conditions of the catchment and it cannot be used as a model to some other locations because local conditions of the parameters and its relation to one parameter to other may change. It is suggested to device the parameter scoring based on the local conditions and demand of the project.

#### 4.2.3 Conclusions:

- Looking at the available monsoon runoff potential from surface reservoir body and catchment & other geohydrological and meteorological parameters construction of 7 recharge shaft in Sangrampur and 6 recharge shafts in Gudarkheda located in Burhanpur and Piploda blocks respectively are found feasible.
- The ground water through exploratory drilling at Gudarkheda and Sangrampur sites has revealed the thickness of alluvium is 8-9 m. in Gudarkheda and 5-7 in Sangrampur comprising mainly clay and silt of basaltic origin.
- Two aquifer systems have been observed in newly constructed recharge shaft borewells in

both locations. In General, aquifer-1 is up to 22mbgl and 28 mbgl (Unconfined & phreatic) in Gudarkheda recharge shaft bore wells No. 1 and 2 respectively while aquifer-2 is 54.46 mbgl and 80 mbgl (Semi confined/confined) in Gudarkheda recharge shaft bore wells No. 1 and 2 respectively.

- In Sangrampur aquifer-1 is up to 26mbgl and 32 mbgl (Unconfined & phreatic) in recharge shaft bore wells No. 1 and 2 respectively while aquifer-2 is 44.91 mbgl and >60 mbgl (Semi confined/confined) in Gudarkheda recharge shaft borewells No. 1 and 2 respectively. The two aquifer system is a new finding during the drilling of recharge shaft.
- Considering average 2.5 lps intake rate of each recharge shaft in Gudarkheda, and average 55 days of monsoon period<sup>1</sup>, the potential recharge could be 11,880 cu. m. per recharge shaft and for 6 recharge shafts it will be 71,280 cu. m. While in Sangrampur average 1.5 lps intake rate each recharge shaft (considering the recharge shaft depth range between 90 to 110 m to augment the recharge capacity), the capacity of recharge for monsoon considering average 60 days period it could be 7,776 cu. m. per recharge shaft and for 7 recharge shafts it will be 54,432 cu. m.

#### 4.3 Construction of Recharge Shafts:

Post field verification and consultations with officials of Water Resources Department (WRD), Government of Madhya Pradesh, UNDP and the farmers of the area, 4 locations, two each in Sangrampur (Burhanpur) and Gudarkheda (Ratlam), were finalized for construction of demonstration recharge shafts for ground water recharge.

Two Exploratory Wells (recharge shafts) in each district were drilled after verification of sites to locate water bearing aquifers down to the depth of 62.65 m and 93 m bgl at Sangrampur in Burhanpur District and at Gudarkheda in Ratlam District, respectively.

**Table 5: Locations of Recharge Shafts at Sangrampur and Godarkheda**

District	Village	Coordinates	Additional works
Burhanpur	Sangrampur	N21.21876, E75.38106	
		N21.21608, E 76.3788	
Ratlam	Gudarkheda	N23.5618, E74.8752	LBS (2)
		N23.5641, E74.8888	Retaining wall & LBS (2)

At the above sites both at Gudarkheda village in Ratlam District and Sangrampur Village in Burhanpur District, clay layers were encountered during boring of wells. The boring was done with 8” diameter drilling machine. The depth wise lithological log was collected and preserved for the further study of the aquifer. Casing was inserted to the depth of hard rock strata which varies from 7.5 m to 20 m as the case may be. The lithological logs of the bore wells were prepared and presented for the further study of slug test. Samples of

<sup>1</sup> Madhya Pradesh Climate Change Vulnerability Assessment Report, 2018

rocks obtained during boring from various depths were properly bagged, labeled and handed over to the WRD representatives for records and future studies.

Civil works to contain the filter media around the shaft casing, horizontal slotting of casing, covering the slotted sections with coir ropes and filling the filter media and capping the bore hole casing with an iron cap were completed as per TOR and need. Sign boards detailing the location, purpose and stakeholders were also installed near the demo recharge shafts. The filter section is circular in Burhanpur District, whereas in Ratlam District it is square shape as per TOR design. The cross-section drawings of the recharge shafts at Sangrampur and Gudarkheda are at Annexure-1 &2

#### **4.3 Additional Works (Construction of Retaining wall & Loose Boulder Structures at Gudarkheda , Ratlam District):**

One retaining wall and 4 LBS (2 each for recharge shaft points) as mentioned in Table 5 above were constructed. The cross-section drawings of the same at Sangrampur and Gudarkheda are at Annexure-3&4.

#### **4.4 Video Recording:**

Video recordings of slug tests and recharge shaft construction were done and time to time submitted to UNDP.

#### **4.5 Collection of Water Samples:**

Water samples from bore wells located near the recharge shaft points for Sangrampur and Gudarkheda were collected in clean plastic bottles, marked properly and handed over to UNDP representatives for further analysis. GPS points for monitoring wells are as follows:

**Table 6: Location of monitoring wells at Gudarkheda and Sangrampur**

S. No.	Location	Longitude	Latitude	Depth	Sample No.
1.	Gudarkheda	74°52'44.7"	23°33'46.5"	60	1
2.	Gudarkheda	74°52'47.8"	23°33'44.6"	120	2
1.	Sangrampur	76.373922	21.214622	140	3
2.	Gudarkheda	76.318567	21.217243	213.36	4

#### **4.6 Meetings cum Capacity Building Programme at the village level:**

MWS level meetings at Sangrampur (Burhanpur) and Gudarkheda (Ratlam) were organized on 10<sup>th</sup> and 14<sup>th</sup> August 2018, respectively. Representatives of WRD, Gram Panchayat, UNDP and NCHSE and farmers of the respective villages participated in the meetings. While UNDP representatives explained the objectives of the project, the representatives from WRD explained what WRD is doing for the conservation of water and making it available for the villagers. Through a detailed presentation and video tutorials, NCHSE representatives have



explained the causes of water scarcity, the need for conservation of water to counter the impact of **climate change** and how the recharge shafts created as **climate adaptation** option would benefit the farmers by improving ground water conditions.

Through the video, farmers were also explained the process of construction of recharge shafts and their maintenance requirement. Thereafter, all presented in the meeting visited one of the recharge shafts, where again purpose and maintenance needs were explained to the farmers. Farmers were also advised how they can use their dried bore wells to facilitate ground water recharge adopting the procedure explained to them. Officials of WRD and farmers numbering 51 in Sangrampur and 62 in Gudarkhera participated in the training. The list are at Annexure-5 & 6 .

#### **4.7 Completion Certificate**

Office of the Executive Engineer, WRD of both the districts have issued work completion certificates. The copies of the same are at Annexure –7 & 8.

#### **4.8 Challenges Encountered:**

##### **4.8.1 Sangrampur, Burhanpur:**

- Coordinates for recharge shafts as mentioned in the TOR were found to be inaccessible to heavy boring machine and vehicles carrying the construction materials. Therefore, approach road had to be created for both the sites in Sangrampur, causing loss of time and cost overrun.
- Area faces acute water crisis. Therefore, water was not readily available for slug tests and construction, causing loss of time and cost overrun.

##### **4.8.2 Gudarkheda, Ratlam**

- Arrival of monsoon in time in the area, interrupted works several times. Rain prevented excavation works for civil works for filter after completion of boring. The rains caused filling of filter well with silt and water, this prevented, slotting of bore well casing, and other works of filling of filter. The condition of the approach road to the recharge shaft sites also deteriorated preventing transportation of materials. Due to same reasons, transportation of boulders, cement, sand and iron nets for retaining wall and LBSs could not be done as per schedule, causing loss of time and cost overrun.

#### **5. Recommendations:**

1. Abandoned bore wells and dug wells of farmers and Panchayat be identified and converted as recharge wells;
2. Groundwater monitoring wells of farmers or Panchayats which are not in use can be used for monitoring actual water level of the area.
3. Each recharge shaft and piezometers can be the best monitoring wells as these are not

used for groundwater abstraction while taking other running wells fitted with motor pumps as monitoring wells may not give actual data.

4. Chemical quality of runoff water to be used for ground water recharge through recharge shafts or other bore wells and dug wells to be checked before its use as recharge water to protect the contamination of aquifer system.
5. Water of upper catchments running in the water bodies should be considered for water balancing in the area.
6. Excess water of any storage facility should be returned to the stream having recharge shaft.
7. Groundwater recharge shaft should be monitored at regular intervals to assess the rate of infiltration and possible clogging problems.
8. Impact evaluation may require monitoring recharge shaft, the groundwater regime, the changes in water recharge model, the model of harvesting and productivity of crops and / or water quality.
9. Monitoring groundwater levels must monitor the impact of individual structures and then can be extended to monitor the impact of a group of artificial recharge systems groundwater.
10. A system for ground water quality monitoring before, during and after the operation of the system has to be adopted.

Annex-1  
Design & Cross section of Recharge Shaft at Sangrampur, Burhanpur

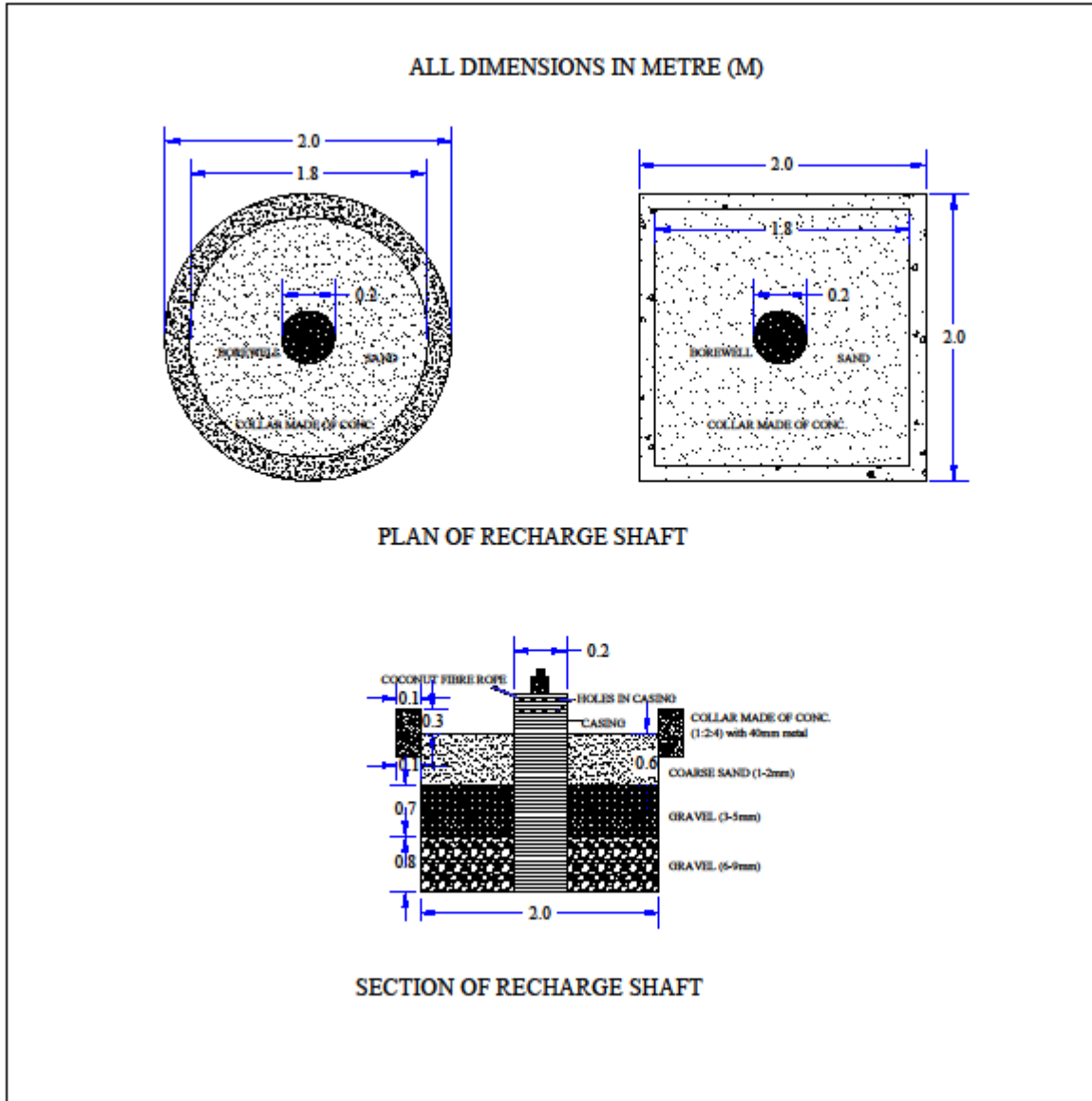

## Annex-2 Design & Cross section of Recharge Shaft at Gudarkheda, Ratlam

ALL DIMENSIONS IN METRE (M)

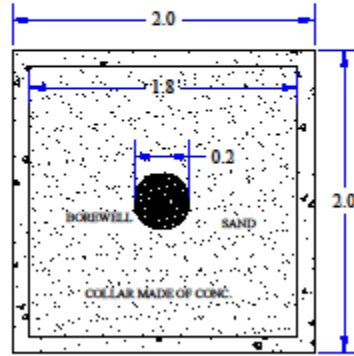

PLAN OF RECHARGE SHAFT

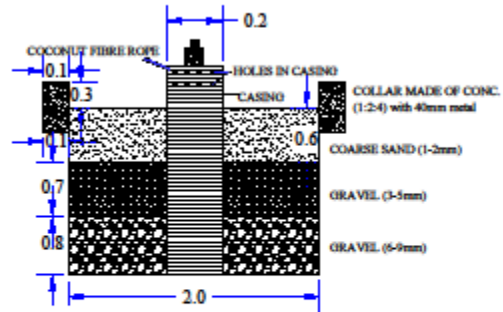

SECTION OF RECHARGE SHAFT

**Annex-3**  
Design & Cross section of Retaining Wall at Gudarkheda, Ratlam

ALL DIMENSIONS IN METRE (M)

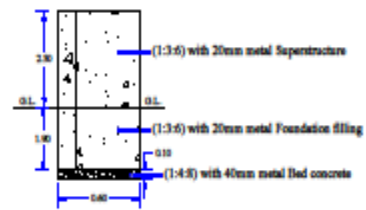

SECTION OF RETAINING WALL

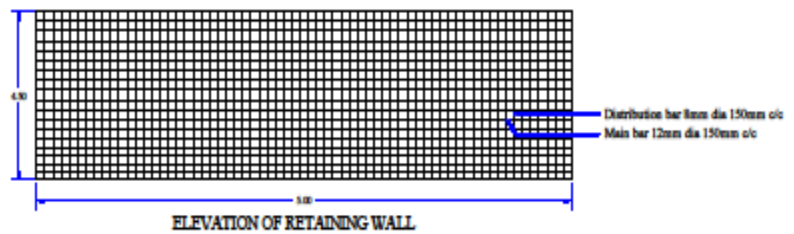

**DETAIL DRAWING OF RCC RETAINING WALL 5.00MX4.50M**

**Annex-4**  
Design & Cross section of LBS at Gudarkheda, Ratlam

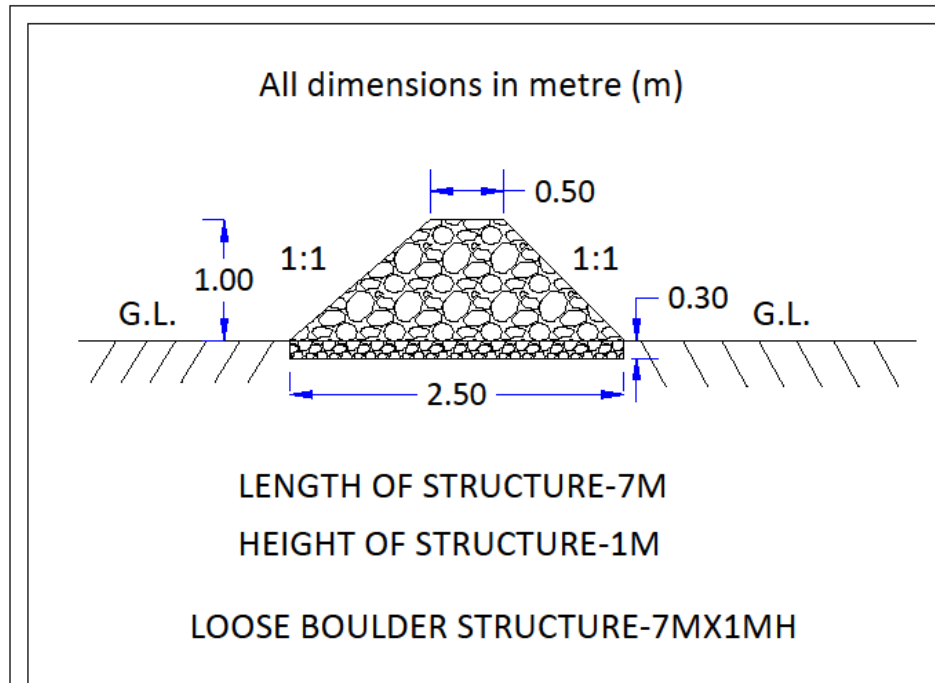
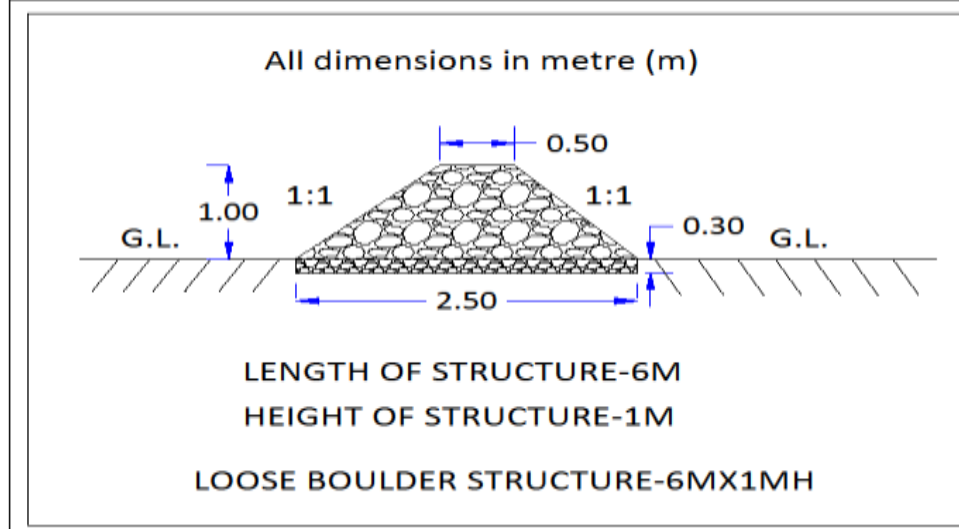

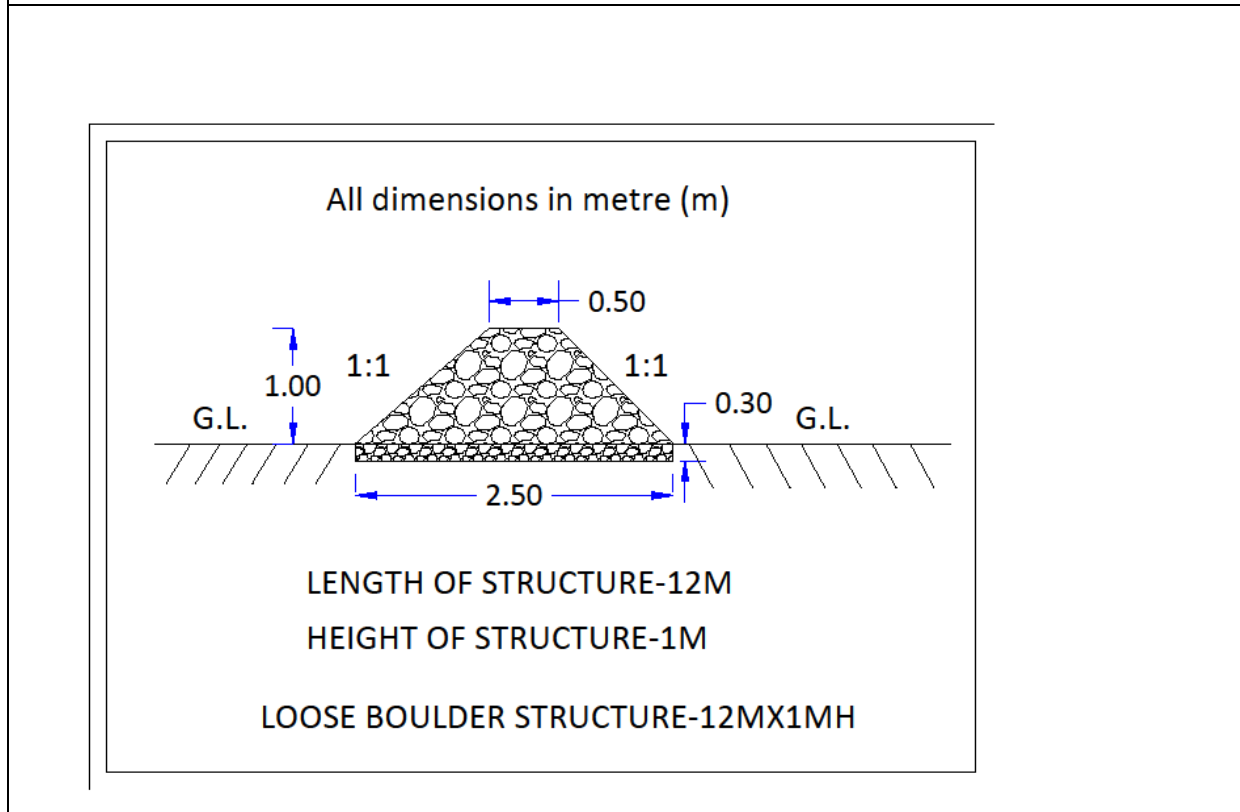
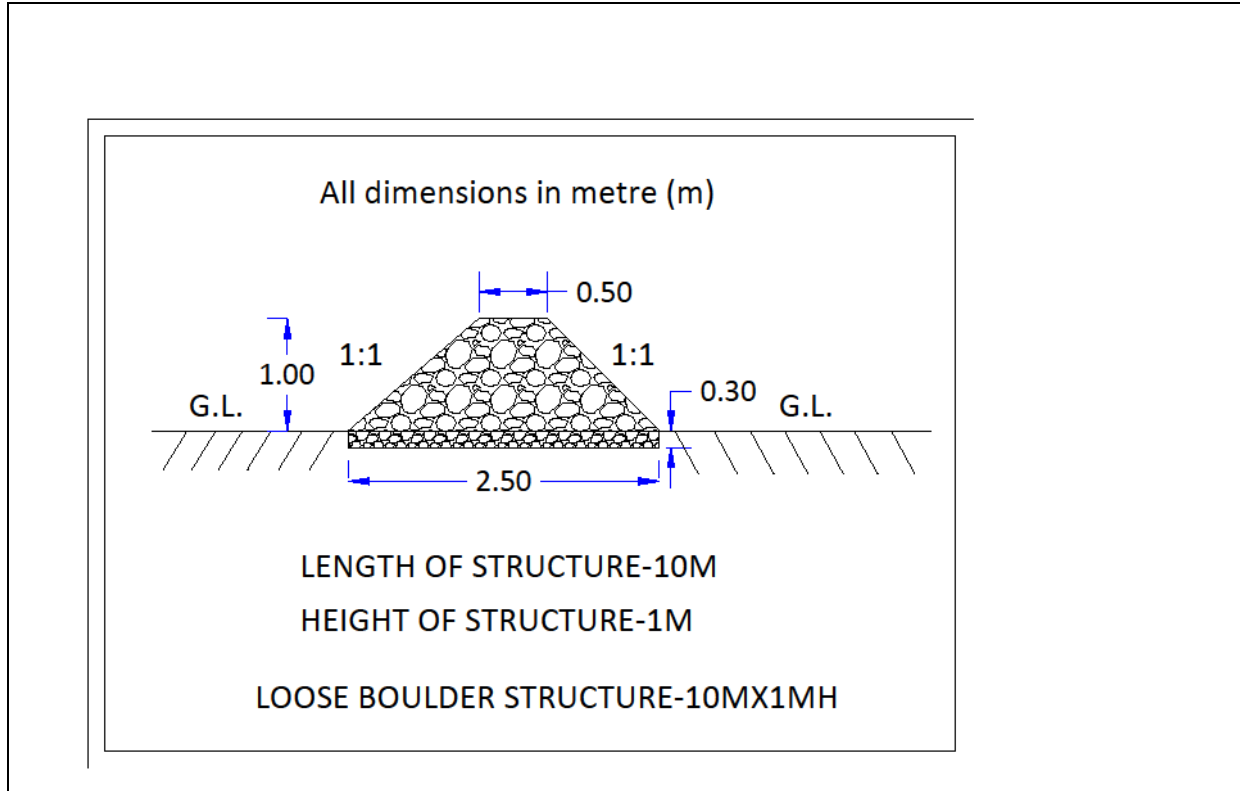

## Annex -5

## List of participants at Sangrampur, Burhanpur

सहभागिता आधारित भूमिगत जल का संवर्धन एवं प्रबंधन (पायलट) परियोजना  
एक दिवसीय कार्यशाला सह प्रशिक्षण  
स्थान संवामपुर गांव  
दिनांक: 10-8-2018

अनु क्रमांक	नाम	संगठन	मोबाइल नंबर	हस्ताक्षर
	श्री. नारायण रामदास प्रहरे		6660160202	श्री. नारायण रामदास प्रहरे
	विनोद मधुकर रागे		9377853533	विनोद मधुकर रागे
	मधुकर रघुनाथ महेजरे		9149834644	मधुकर रघुनाथ महेजरे
	श्री. राजन देवरुप		9650344924	श्री. राजन देवरुप
	जगन्नाथ सातारकर		8230293300	जगन्नाथ सातारकर
	चंद्र कांत काठी		8959696087	चंद्र कांत काठी
	अरुण भगवान महेजरे		9669675336	अरुण भगवान महेजरे
	सुनील चौधरी		7226861013	सुनील चौधरी



सहभागिता आधारित भूमिगत जल का सर्वर्धन एवं प्रबंधन (पायलट) परियोजना  
एक दिवसीय कार्यशाला सह प्रशिक्षण

तिथि: 10-8-2018









स्थान: संगमपुर गांव

अनु क्रमांक	नाम	संगठन	मोबाइल नंबर	हस्ताक्षर.
1	आशिषा शर्मा			318191
2	निर्मल पटेल			Ravi
3	शक्ति शर्मा			Shree
4	योगेश पटेल			
5	आशिषा शर्मा			318191
6	शक्ति शर्मा			कनिका
7	आशिषा शर्मा			शशिका
8	आशिषा शर्मा			Shree

सहभागिता आधारित भूमिगत जल का स्वर्धन एवं प्रबंधन (पायलट) परियोजना  
एक दिवसीय कार्यशाला सह प्रशिक्षण

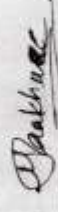
तिथि: 10-8-2018

स्थान संग्रामपुर गांव

अनु क्रमांक	नाम	संगठन	मोबाइल नंबर	हस्ताक्षर
	निलेश सदाशिव महाजन		9139218888	
	रिपड प्रल्हाद पाटिल		9826716970	
	गणेश सदाशिव महाजन		9753742603	
	चमन धनराज सोनवणे		6263635677	
	सुकेश संतोष महाजन		6260816881	
	जेतन सुभाष राठोर		9755365672	
	निवेश पांडुरंग महाजन		997256016	
	नाकेशिका महाजन		8826994829	
	दिमित सोकरन गावेल		9753240106	

सहभागिता आधारित भूमिगत जल का संवर्धन एवं प्रबंधन (पायलट) परियोजना  
एक दिवसीय कार्यशाला सह प्रशिक्षण

तिथि: 10-8-2018

स्थान: संगमपुर गांव

अनु क्रमांक	नाम	संगठन	मोबाइल नंबर	हस्ताक्षर
①	सुखर मदान		9575765688	ईश्वर सपरा
②	प्रताप पाटील		8085988813	प्रताप विमान मदन
③	राधिका मदान			
④	मुक्ता मदान		8959696883	
⑤	अश्विनी मदान		9617220070	
⑥	मुक्ता मदान		9826490605	
⑦	राधिका मदान			
⑧	सुखिन मदान		8120463696	सुखिन मदान

सहभागिता आधारित भूमिगत जल का सर्वेक्षण एवं प्रबंधन (पायलट) परियोजना  
एक दिवसीय कार्यशाला सह प्रशिक्षण

तिथि: 10-8-2018







स्थान संग्रामपुर गांव

अनु क्रमांक	नाम	संगठन	मोबाइल नंबर	हस्ताक्षर
	योगेश लोकिशर महाक		9977573350	Jogesh
	रुपेश अरुण महाजन		8208146416	रुपेश →
	राजेश कुमार शिरोपती		98 23288316	राजेश शिरोपती
	दिनेश कुमार शिरोपती		9691177656	दिनेश शिरोपती
	पंकज महाजन महाजन		9171260499	पंकज
	अशोक महाजन		8224985298	अशोक
	कुशीमान शिरोपती		6264631418	कुशीमान

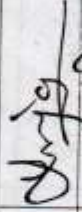
सहभागिता आधारित भूमिगत जल का सवर्धन एवं प्रबंधन (पायलट) परियोजना  
 एक दिवसीय कार्यशाला सह प्रशिक्षण

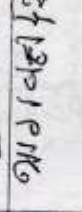
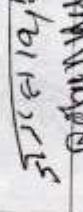
तिथि: 10-8-2018

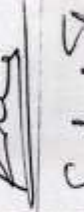
स्थान संगमपुर गांव

अनु क्रमांक	नाम	संगठन	मोबाइल नंबर	हस्ताक्षर
	योगेश विश्वनाथ		9179929240	
	अविंद्र कुमार तारकर		9827227230	
	मंशावाग कोषकर		9754572361	
	हाशवाग खैरग			
	मोटान प्रियमन			
	रोहन			
	sunil			
	Sambant			

सहभागिता आधारित भूमिगत जल का सवर्धन एवं प्रबंधन (पायलट) परियोजना  
एक दिवसीय कार्यशाला सह प्रशिक्षण

तिथि: 10-8-2018

स्थान: संगमपुर गांव

अनु क्रमांक	नाम	संगठन	मोबाइल नंबर	हस्ताक्षर
	दिनेश शर्मा		9691147656	दिनेश शर्मा
	प्रज्वल शर्मा		9425008956	प्रज्वल शर्मा
	Dr. Radip Mondal	NCHSE	9425081414	Dr. Radip Mondal
	K.S. Banerjee	NCHSE	9425081414	K.S. Banerjee
	Avinash Shrivastava	NCHSE	9425081414	Avinash Shrivastava
	मोहम रजिरे	स.स.पिप	8963986040	मोहम रजिरे

**Annex -6**  
**List of participants at Gudarkheda, Ratlam**

WORKSHOP ON IMPLEMENTATION OF RECHARGE SHAFT, <del>...</del> (SANGRAMPUR) RATLAM 14/8/18			
क्र०	नाम	मोबाईल	पता
1	राजेंद्र कुमार	8462075830	शिवपुर गांव
2	दिलीप सिंह	9165780181	दिलीप सिंह
3	शंकर		शंकर
4	राधेश्याम	8120731655	राधेश्याम
5	श्यामसुंदर	948989273	श्यामसुंदर
6	मुकुंद कर्माड योदान	990749553	मुकुंद
7	गोविंद		गोविंद
8	सुरेंद्र सिंह	9753156976	सुरेंद्र
9	श्यामसुंदर	959885336	श्यामसुंदर
10	गोपाल		गोपाल
11	भारत सिंह युडावल	912101	भारत सिंह
12	कमल सिंह	भारत सिंह	कमल सिंह
13	भारत सिंह नाथ	भारत सिंह	भारत सिंह
14	कमल सिंह	भारत सिंह	कमल सिंह
15	विष्णु		विष्णु
16	शंकर कर्माड		शंकर
17	श्यामसुंदर		श्यामसुंदर
18	शंकर		शंकर
19	श्यामसुंदर सिंह	श्यामसुंदर	श्यामसुंदर
20	कमल सिंह	भारत सिंह	कमल सिंह
21	समर्थ	9926557414	समर्थ
22	श्यामसुंदर		श्यामसुंदर
23	कमल सिंह		कमल सिंह
24	श्यामसुंदर		श्यामसुंदर
25	गोविंद सिंह		गोविंद
26	योगेश		योगेश
27	श्यामसुंदर	8120731704	श्यामसुंदर
28	कमल सिंह		कमल सिंह

14/8/18		Workshop on Recharge Shaft Village - Gurdankheda. Zilla - Katlam	
Sl. No.	Name	Mobile No.	Address
29	सिंहलाल		
30	अमलसिंह		
31	लखवतसिंह		
32	विश्व		
33	मोहनसिंह	9977022913	
34	विजय		
35	गोपालसिंह		
36	सुभास	82230143	
37	पिण्ड	9111731596	
38	रामलाल		
39	रविशंकरसिंह	8889162906	
40	श्रीधरसिंह		
41	ब्रह्मसुन्दर		
42	नाथयण		
43	रामपाल सुभाष		
44	ब्रह्मनारायण	797429954	
45	गोपालसिंह केका		
46	दीपक		
47	श्यामसुन्दर	8225010722	
48	शंकरसिंह	888937452	
49	शंकरलाल	9636483679	
50	उदयराम डांडा		
51	अनंत राम	9600064923	
52	दिनेश वाघेला	7604001160	
53	हरिनारायण प्रजापत		
54	लखनसिंह जोषी	7974833651	
55	योगेश केत	9754955028	
56	डा. पी. जामलनाथ	5753022579	



Sl. No.	नाम	संस्थान	मोबाइल नं.	एन/एल
157	जितेंद्र सिंह चौहान		9424591686	Jitendra
60	न. न. लाल पावला		9111334878	nn
61	क. 0. रमेश 0. अ. न. श. NCHSE		9425681414	K. Ramesh
62	अ. व. म. श्रीवास्तव UNDP		9676918532	AVM
63	श्री व. म. त. चौधरी UNDP		9560328916	SVMT
64	S.I.S. A. J. R. विद्यापीठ		9926402471	S.I.S.
65	य. 2. 2. 5. 1. 1.		9425327328	Yem Gupta
66	8. विकास श. श. क. ल. NCHSE		9406528098	VKS
67	श्री. व. म. त. चौधरी		9754480521	SVMT
68	श्री. व. म. त. चौधरी A.G.H.		942411634	SVMT
69	Rilip-Joshi sub Engrg.		989356674	Rilip
70	pankaj Rathore (T.L. NCHSE)		9685323213	Pankaj
71	Jaideep Singh (Engrg.) NCHSE		9116513244	Jaideep

71

**Annex -7**  
**Completion Certificate Sangrampur, Burhanpur**

कार्यालय कार्यपालन यंत्री, जल संसाधन संभाग, जिला बुरहानपुर, म.प्र.

दिनांक: 27-06-2018

कार्य पूर्णता, उपयोगिता प्रमाण पत्र

पत्र क्र. 1501 / जल संसाधन विभाग /

बुरहानपुर, दिनांक: 21/8/2018

प्रमाणित किया जाता है कि UNDP के सहायोग से रिचार्ज शाफ्ट क्र. 1 (GCP-75.38106E, 21.21876N) रिचार्ज शाफ्ट क्र. 2 (GCP-76.3788E, 21.21608N) का निर्माण कार्य ग्राम संग्रामपुर, ग्राम पंचायत - संग्रामपुर, विकास खण्ड - बुरहानपुर मे अनुबंध क्र. 2018/046 के अनुसार स्वीकृति प्रदान की गई थी।

उक्त कार्य प्राकलन व स्थान की आवश्यकतानुसार दिनांक 27-6-2018 को पूर्ण कर लिया गया है।



उप अभियंता  
जल संसाधन उपसंभाग क.1  
बुरहानपुर (म.प्र.)



अनुविभागीय अधिकारी,  
जल संसाधन उपसंभाग क.1  
बुरहानपुर (म.प्र.)



कार्यपालन यंत्री  
जल संसाधन संभाग  
बुरहानपुर (म.प्र.)

**Annex -8**  
**Completion Certificate Gudarkheda, Ratlam**

कार्यालय कार्यपालन यंत्री, जल संसाधन विभाग, जिला रतलाम, म.प्र.

दिनांक: 14-08-2018

कार्य पूर्णता, उपयोगिता प्रमाण पत्र

पत्र क्र. 3434 / जल. संसाधन विभाग / रतलाम, दिनांक 14.08.2018

प्रमाणित किया जाता है कि UNDP के सहयोग से रिचार्ज शाफ्ट क्र. 1 (GCP-74.8752E, 23.5618N) रिचार्ज शाफ्ट क्र. 2 (GCP-74.8888E, 23.5641N) का निर्माण कार्य ग्राम गुडरखेड़ा, ग्राम पंचायत - गुडरखेड़ा, विकास खण्ड - पिपलीदा में अनुबंध क्र. 2018/046 के अनुसार दो रिचार्ज शाफ्ट, एक रिटर्निंगवाल तथा 4 लूज बोल्ट्स संरचना की स्वीकृति प्रदान की गई थी।

उक्त कार्य प्रांकलन व स्थान की आवश्यकता अनुसार दिनांक 14-8-2018 को पूर्ण कर लिया गया है।

*[Handwritten Signature]*  
कार्यपालन यंत्री  
जल संसाधन विभाग  
जिला रतलाम (म.प्र.)

संलग्न: रिचार्ज शाफ्ट की ड्राइंग।

**Photographs showing various stages of recharge shaft construction at Sangrampur, District Burhanpur**



**Photographs showing various stages of recharge shaft construction at Sangrampur,  
District Burhanpur**



**Photographs showing various stages construction of of recharge shaft and retaining wall at Gudarkheda, District Ratlam**



**Recharge Shaft**



**Retaining Wall**

### Loose Boulder Structures (LBS) in Gudarkheda, Ratlam

	
<p><b>LBS-1</b></p>	<p><b>LBS-2</b></p>
	
<p><b>LBS-3</b></p>	<p><b>LBS-4</b></p>





**Photographs showing Slug test in progress**

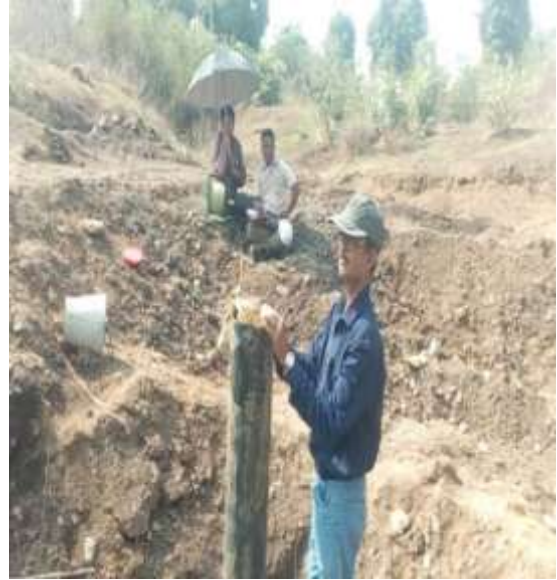

**Photographs of MSW meeting cum capacity building programme at Gudarkheda,  
District Ratlam**



**Photographs of MSW meeting cum capacity building programme at Sangrampur, District Burhanpur**

